

Preliminary

EN

MHL 390



 300 kW

 250 kW

 76.2–87.0 t

 max. 24.5 m

 **FUCHS**[®]
A TEREX BRAND

TECHNICAL DATA

Operating Weight without Attachments

MHL390 F	76,2–87,0 t
----------	-------------

Diesel Engine

	EU Stage V / US EPA Tier 4	EU Stage IIIA / US Tier 3*
Manufacturer and model	Deutz TCD 12.0 V6	TCD2015 V06
Design	6-cylinder-V-engine	6-cylinder-V-engine
Functionality	4-stroke diesel, common rail direct injection, turbo-charged with intercooler, controlled exhaust gas recirculation, diesel particulate filter with continuous regeneration and SCR catalytic converter	4-stroke diesel, common rail direct injection, turbo-charged with intercooler
Engine power	300 kW	273 kW
Rated speed	1800 rpm	1800 rpm
Displacement	12.0 l	12.0 l
Cooling system	Water and charge air cooling with temperature controlled fan speed	Water and charge air cooling with temperature controlled fan speed
Exhaust emission standard	EU Stage V / US EPA Tier 4	EU Stage IIIA / US Tier 3*
Kraftstofftank	822 l Diesel	822 l Diesel
Urea Tank	85 l AdBlue	□

Electric Motor

Power	250 kW
Total connected load	304 kW
Motor start	Via soft start
Optional cable reel	Up to 50 metres (other lengths on request)

Electrical System

Alternator	28 V / 100 A
Operating voltage	24 V
Battery	2 × 12 V / 110 Ah / 750 A
Lighting system	2 × LED floodlights at the front of the machine, rear parking lights and indicator lights
Optional equipment	30 kW DC generator with insulation monitoring

Travel Drive

Hydrostatic drive through infinitely variable axial piston motor and directly mounted travel brake valves, all-wheel drive

Travel speed	max. 8 km/h
Gradeability	max. 11 %
Turning radius	12.85 m

Swing Drive

Slewing ring	Internally geared double row slewing ring bearing, greasing via automatic lubrication system
Drive	2-stage planetary gear with integrated multi-disc brake
Uppercarriage swing speed	0–5.5 rpm infinitely variable
Slewing lock	Electronically activated

Undercarriage

Front axle	Planetary drive axle with integrated drum brake, rigidly mounted
Rear axle	Planetary drive axle with integrated drum brake, oscillating axle with selectable oscillating lock
Outriggers	4-point stabilizers
Tyres	Solid rubber 8-ply 14.00-24

Brakes

Service brake	Hydraulically operated braking system, acting on all four wheel pairs
Parking brake	Electrically operated disc brake, acting on both axles

Hydraulic System

Max. pump capacity	720 lpm and 200 lpm (for swing drive)
Max. operating pressure	320 / 360 bar
Hydraulic oil tank	660 l
Filtration	Flow-optimized return filters, integrated in the oil tank. Filter fineness defined at a beta value $\beta(10) = 200$ guarantees 99.5% separation of dirt particles with 10 μm . Very good separation values are already achieved with particle sizes of 3 μm . Generously dimensioned for long operating times.
Cooling system	Separated high-performance cooler with temperature-dependent fan drive

Operator's Cab

Cab	<p>Infinitely variable hydraulic height-adjustable cabin with sliding door. Reinforced steel structure, soundproofed, heat-insulated panoramic windows for best all-round visibility, front window with roller blind, glass panel in the cabin roof with sliding blind. Heating and air conditioning, separate heat exchangers, fresh and recirculated air filters. Multifunction touch display, bottle holder, paper clip and multiple storage and mounting options. Digital radio (DAB+, USB, Bluetooth and hands-free), USB charging station 5V.</p> <p>Vertically adjustable cabin: viewing height of 6.14 m</p> <p>Vertically and horizontally adjustable cabin (option): 2.2 m forward, with max. viewing height of 6.44 m</p> <p>Hydraulically adjustable cabin "Port": viewing height of 8.8 m</p>	
Air conditioning	Automatic air-conditioning. Infinitely variable heating with 8-speed fan, 10 adjustable air nozzles, 3 defroster nozzles.	
Operator's seat	Air-cushioned comfort seat with swinging armrests / joysticks, safety belt, lumbar support and headrest. Enables fatigue-free work due to universal adjustment options for the seat position, seat inclination and the arrangement of the seat cushion in relation to the armrests and joysticks.	
Monitoring	Ergonomically arranged, glare-free Multifunction display. Automatic monitoring and storage of deviating operating states (e.g. all hydraulic oil filters, hydraulic oil temperature – coolant and charge air temperature – diesel particulate filter loading, steering), visual and audible warning. Diagnostic option for the individual sensors via the multifunction display. Rear view and side view camera on the right with separate monitor	
Schallpegel	EU Stage V / US EPA Tier 4 Sound power level (ambience) L_{WA} 104.4 dB(A) (metered) acc. to directive 2000/14/EC L_{WA} 106 dB(A) (guaranteed) acc. to directive 2000/14/EC Sound pressure level (inside the cabin) acc. to directive ISO 6396 ISO 6396 L_{PA} 73 dB(A)	EU Stage IIIA / US Tier 3* Sound power level (ambience) L_{WA} 106 dB(A) (metered) acc. to directive 2000/14/EC L_{WA} 106 dB(A) (guaranteed) acc. to directive 2000/14/EC Sound pressure level (inside the cabin) acc. to directive ISO 6396 ISO 6396 L_{PA} 73 dB(A)
Vibrations	Weighted r.m.s. value of acceleration of upper limbs: under 2.5 m/s ² (98 in/s ²) Weighted effective value of acceleration for the seat and feet: under 0.5 m/s ² (20 in/s ²)	
Certified in accordance with CE regulations		

* for low-regulated markets

EQUIPMENT

Diesel Engine	Standard	Option	Operator's Cab	Standard	Option
Water and charge air cooler	●		Cabin with penetration resistant glass front and top (classification P5A)		●
Temperature-dependent fan drive	●		Cabin with bullet-proof glass (classification P8B)		●
Reversible fan		●	Windshield washer system	●	
Direct electronic fuel injection / common rail	●		Washing device for roof window		●
DEF injection, passive regeneration	●		Roof window clear glass	●	
Advanced automatic idle incl. engine shut-off function	●		Air-cushioned operator seat with headrest, seatbelt and lumbar support	●	
ECO and Power Mode	●		Seat heating		●
Engine diagnostics interface	●		Joystick steering	●	
Undercarriage			Steering column, height and tilt adjustable		●
All-wheel drive	●		Air Conditioner	●	
Disk brakes	●		Auxiliary heating incl. timer		●
Rear axle oscillating lock	●		Multi-function display	●	
4-point stabilizers	●		Document clip	●	
Stabilizer cylinder with integrated, double-sided shut-off valves	●		FOPS Guard		●
Piston rod protection for support cylinder	●		Cabin front and top guard		●
Tool box	●		12 V transformer		●
Special paint		●	Digital radio (DAB+, USB, Bluetooth and hands-free system)	●	
Solid rubber 8-ply 14.00-24	●		12 V socket / cigarette lighter		●
Uppercarriage			Fire extinguisher, dry powder with holder		●
Separated high-performance cooling system	●		Travel alarm flashing alarm light with acoustic warning signal		●
Hydraulic oil cooler with temperature-dependent fan drive	●		Other Equipment		
Reversible fan		●	30 kW DC generator		●
Automatic central lubrication system	●		Close proximity range limiter for dipper stick	●	
Rear view camera	●		Coolant and hydraulic oil level monitoring system	●	
Side view camera	●		Overload and working area control		●
Travel alarm		●	Filtration system for attachments		●
Electric refuelling pump		●	Rupture valves for lifting cylinders	●	
Light protection		●	Rupture valves for stick cylinders	●	
Special paint		●	Overload warning device		●
Operator's Cab			Quick coupling on dipper stick	●	
Vertically adjustable cabin	●		Active cyclone prefilter		●
Vertically and horizontally adjustable cabin		●	Hydraulic oil preheating		●
Hydraulically adjustable cabin "Port" with rigid cab riser (viewing height 8.8 m), including 360° camera system, solid rubber tyres 16.00-25 Magnum		●	Lubrication of the grab suspension by central lubrication system	●	
Single-pane safety glass (ESG)	●		LED head lights at the front of the machine	●	
Cabin tinted windows (side, rear)	●		LED light packages		●
Sliding window in cab door	●		Float switch		●
			Fuchs Connect telematics system, incl. 5 years contract	●	

DIMENSIONS

Vertically adjustable cabin

Side view

all dimensions in mm

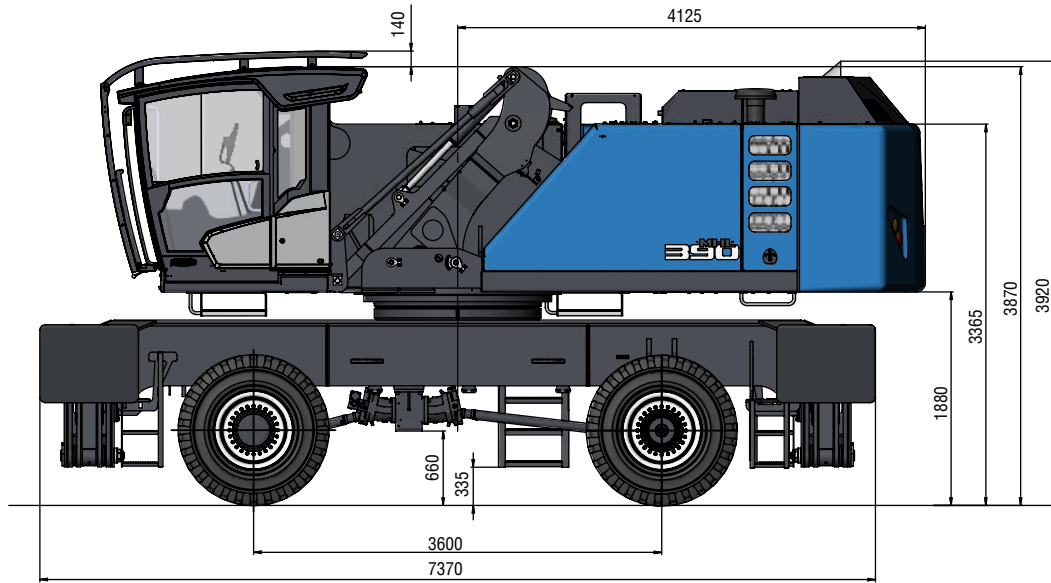

Side view

all dimensions in mm

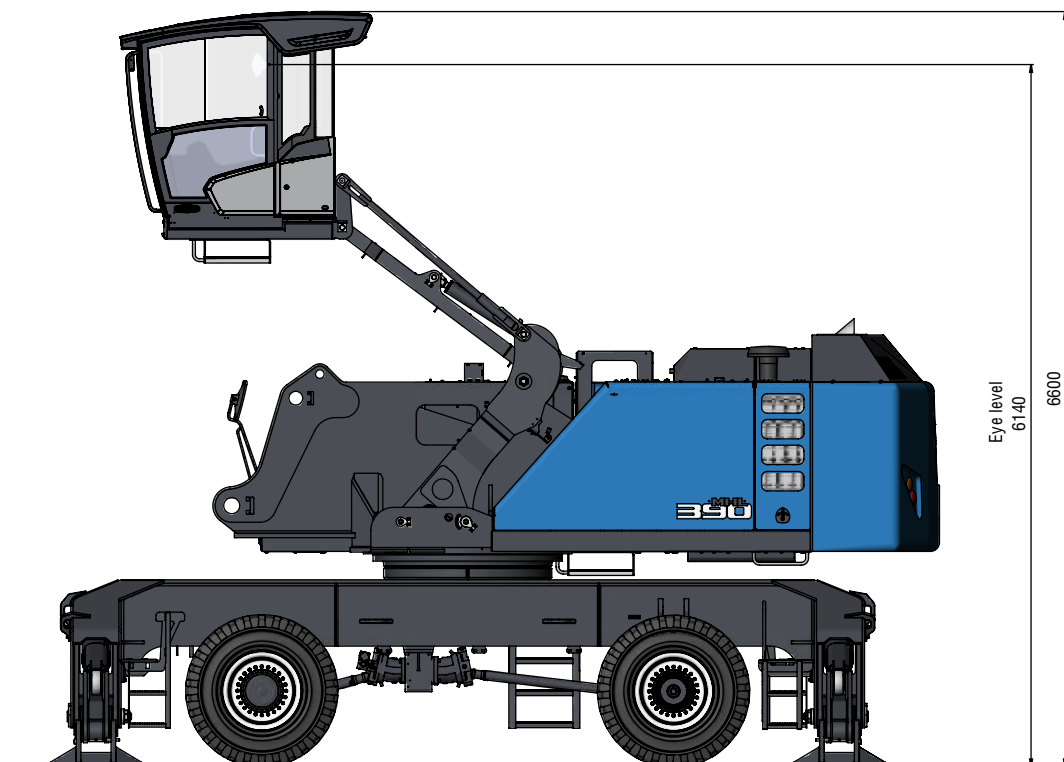

DIMENSIONS

Vertically and horizontally adjustable cabin*

Side view

all dimensions in mm

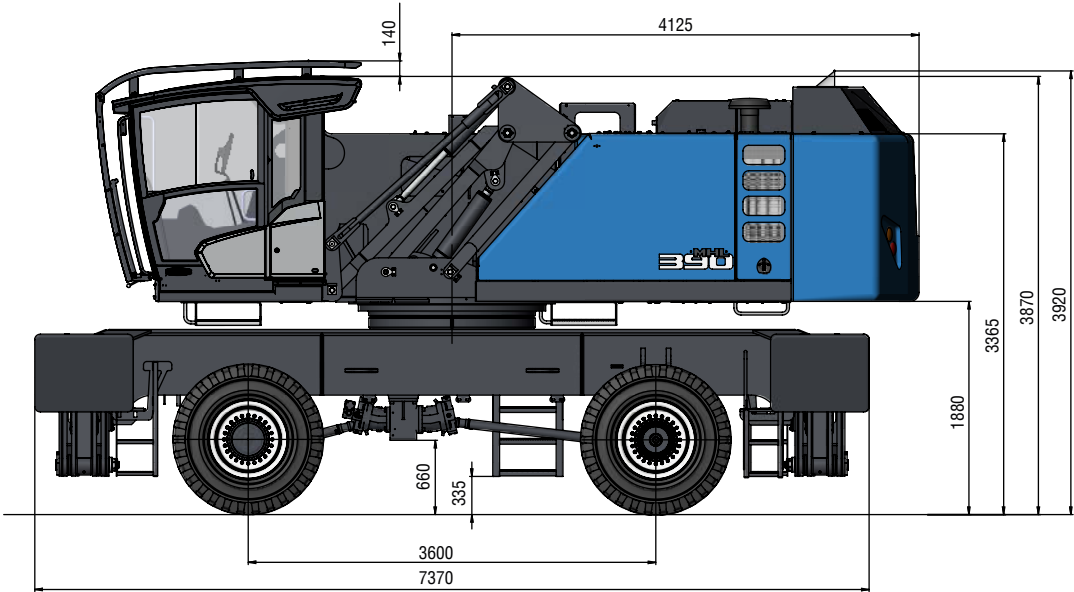

Side view

all dimensions in mm

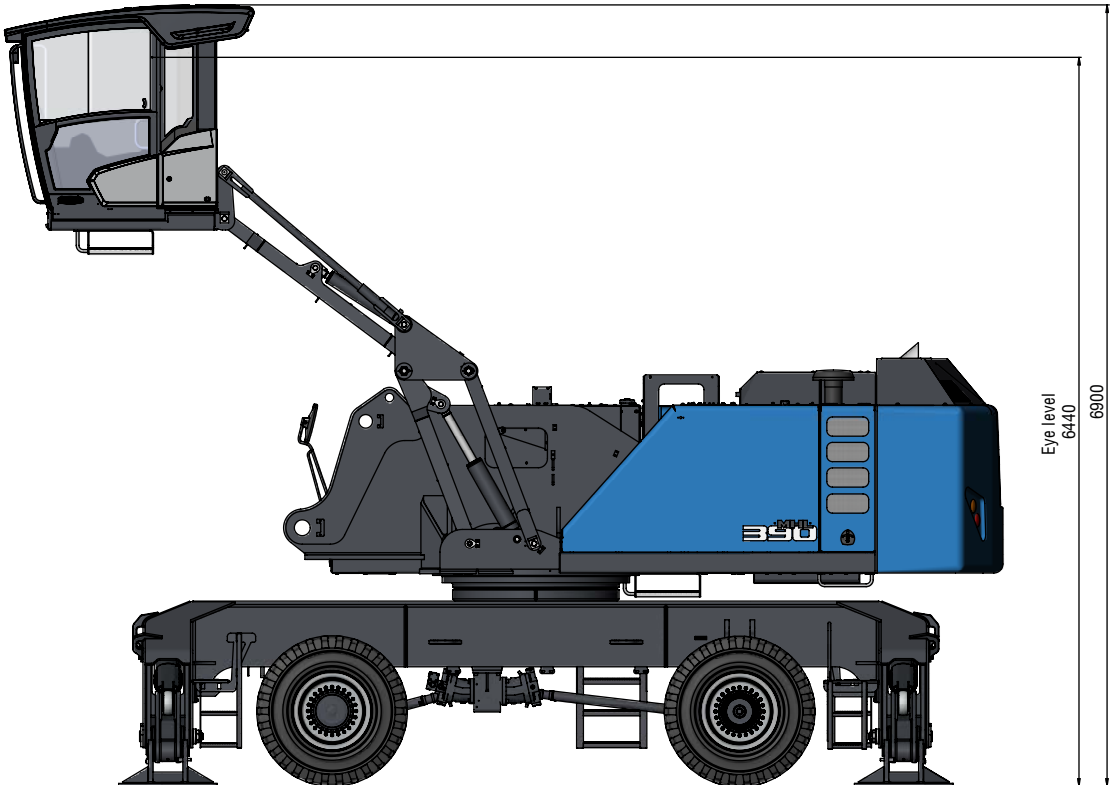

* Option

DIMENSIONS

Front view

all dimensions in mm

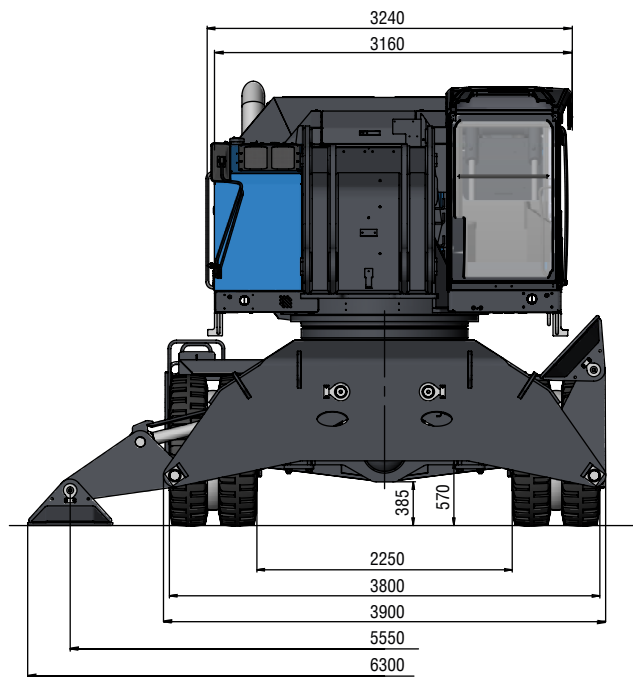

TRANSPORT DIMENSIONS

Loading equipment with dipper stick

all dimensions in mm

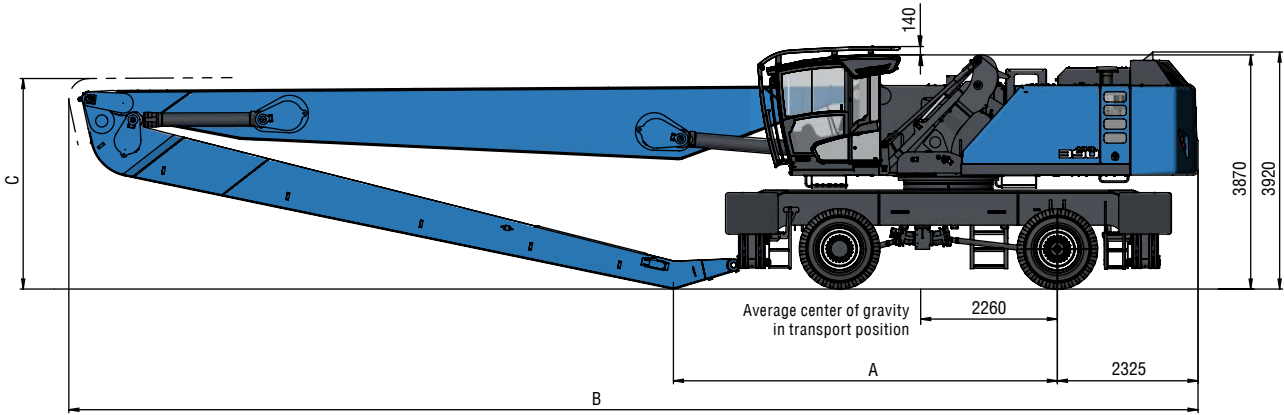

Reach

22 m

24 m

A

6165 mm

6350 mm

B

17315 mm

18665 mm

C

3560 mm

3480 mm

Loading equipment with banana boom

all dimensions in mm

Reach

24.5 m

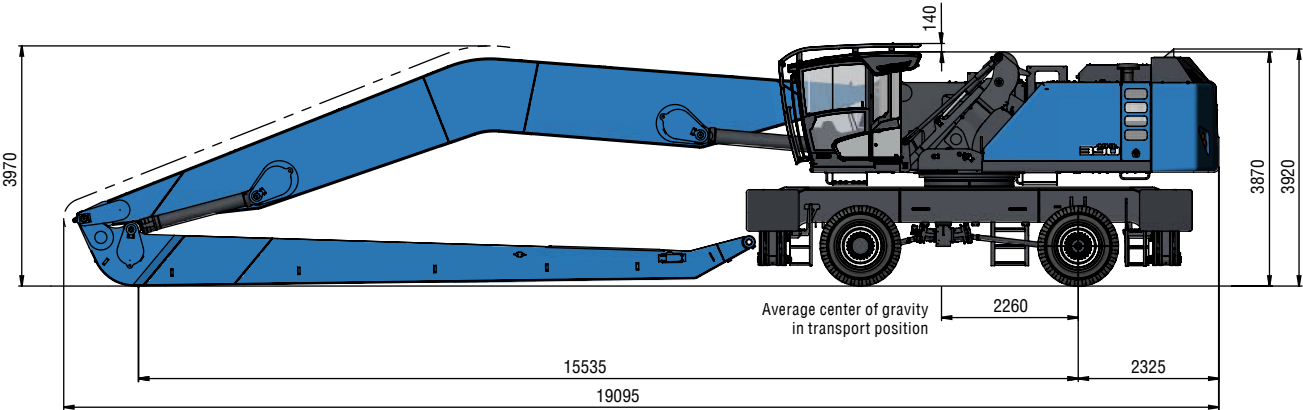







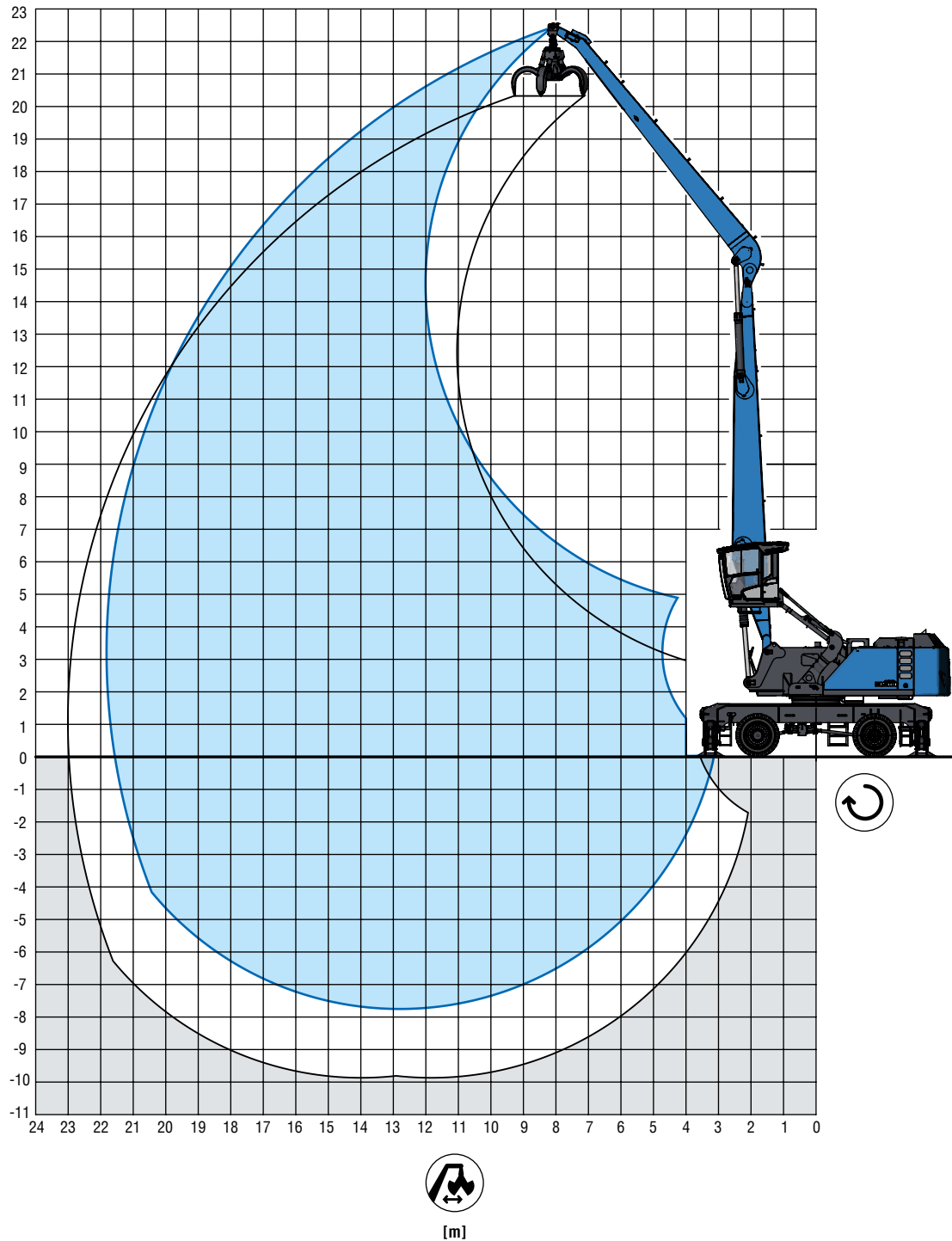

















REACH

22 m with dipper stick

Boom: 11.35 m · Dipper stick: 9.9 m · Cactus grab: 0.8 m³



LIFTING CAPACITY

		  										
		6 m	7.5 m	9 m	10.5 m	12 m	13.5 m	15 m	16.5 m	18 m	19.5 m	21 m
21 m		7.9° (7.9°)										
19.5 m		8.2° (8.2°) 6.1° (6.1°)										
18 m		9.5° (9.5°) 8.2° (8.2°) 6.2° (6.2°)										
16.5 m		9.6° (9.6°) 8.9° (8.9°) 7.9° (7.9°) 5.8° (5.8°)										
15 m		8.8° (8.8°) 8.2° (8.2°) 7.5° (7.5°) 4.9° (4.9°)										
13.5 m		9.5° (9.5°) 8.8° (8.8°) 8.2° (8.2°) 7.7° (7.7°) 6.7° (6.7°)										
12 m		9.6° (9.6°) 8.9° (8.9°) 8.2° (8.2°) 7.7° (7.7°) 7.2° (7.2°) 5.3° (5.3°)										
10.5 m		9.8° (9.8°) 9.0° (9.0°) 8.3° (8.3°) 7.7° (7.7°) 7.2° (7.2°) 6.7° (6.7°)										
9 m		11.3° (11.3°) 10.2° (10.2°) 9.2° (9.2°) 8.5° (8.5°) 7.8° (7.8°) 7.3° (7.3°) 6.7° (6.7°) 4.4° (4.4°)										
7.5 m		13.5° (13.5°) 11.9° (11.9°) 10.6° (10.6°) 9.5° (9.5°) 8.7° (8.7°) 8.0° (8.0°) 7.3° (7.3°) 6.8° (6.8°) 5.5° (5.5°)										
6 m		17.5° (17.5°) 14.6° (14.6°) 12.5° (12.5°) 11.0° (11.0°) 9.8° (9.8°) 8.9° (8.9°) 8.1° (8.1°) 7.4° (7.4°) 6.8° (6.8°) 6.2° (6.2°)										
4.5		25.6° (25.6°) 19.4° (19.4°) 15.7° (15.7°) 13.2° (13.2°) 11.5° (11.5°) 10.1° (10.1°) 9.1° (9.1°) 8.2° (8.2°) 7.4° (7.4°) 6.8° (6.8°) 6.1° (6.1°)										
3 m		23.0° (23.0°) 21.0° (21.0°) 16.7° (16.7°) 13.8 (13.8°) 11.9° (11.9°) 10.4° (10.4°) 9.2° (9.2°) 8.3° (8.3°) 7.5° (7.5°) 6.7° (6.7°) 6.0° (6.0°)										
1.5 m		9.7° (9.7°) 22.0° (22.0°) 17.3° (17.3°) 14.3° (14.3°) 12.1° (12.1°) 10.5° (10.5°) 9.3° (9.3°) 8.3° (8.3°) 7.4° (7.4°) 6.6° (6.6°) 5.8° (5.8°)										
0 m		7.9° (7.9°) 15.0° (15.0°) 17.5° (17.5°) 14.4° (14.4°) 12.2° (12.2°) 10.6° (10.6°) 9.3° (9.3°) 8.2° (8.2°) 7.3° (7.3°) 6.5° (6.5°) 5.6° (5.6°)										
-1.5 m		7.9° (7.9°) 12.7° (12.7°) 17.3° (17.3°) 14.3° (14.3°) 12.1° (12.1°) 10.5° (10.5°) 9.2° (9.2°) 8.1° (8.1°) 7.1° (7.1°) 6.2° (6.2°) 5.2° (5.2°)										
-3 m		8.4° (8.4°) 12.1° (12.1°) 16.6° (16.6°) 13.9° (13.9°) 11.8° (11.8°) 10.2° (10.2°) 8.9° (8.9°) 7.8° (7.8°) 6.7° (6.7°) 5.8° (5.8°)										
-4.5 m		9.0° (9.0°) 12.3° (12.3°) 15.5° (15.5°) 13.1° (13.1°) 11.2° (11.2°) 9.6° (9.6°) 8.4° (8.4°) 7.2° (7.2°) 6.2° (6.2°) 5.1° (5.1°)										
-6 m		12.7° (12.7°) 13.9° (13.9°) 11.9° (11.9°) 10.2° (10.2°) 8.8° (8.8°) 7.6° (7.6°) 6.5° (6.5°) 5.4° (5.4°)										
-7.5 m		8.9° (8.9°) 7.7° (7.7°)										
max. reach 21.8 m												
3.3 m		4.6° (4.6°)										

Recommended attachments upon request



Height



Reach



Center of rotation



4-point supported

The lift capacity values are stated in metric tons (t). In accordance with ISO 10567, the lift capacity values represents 75 % of the static tipping loads or 87% of the hydraulic lifting force (marked *). On solid and level ground the values apply to a swing range of 360°. The (...) values apply in the longitudinal direction of the undercarriage. The weights of the attached load hoisting equipment (grab, load hook, etc.) must be deducted from the lift capacity values. The working load of the lifting device must be observed. In accordance with the EN 474-5 for object handling application hose rupture valves on the boom and stick cylinders, an overload warning device and the lift capacity table in the cab are required. The machine has to be supported on a level ground for object handling application.







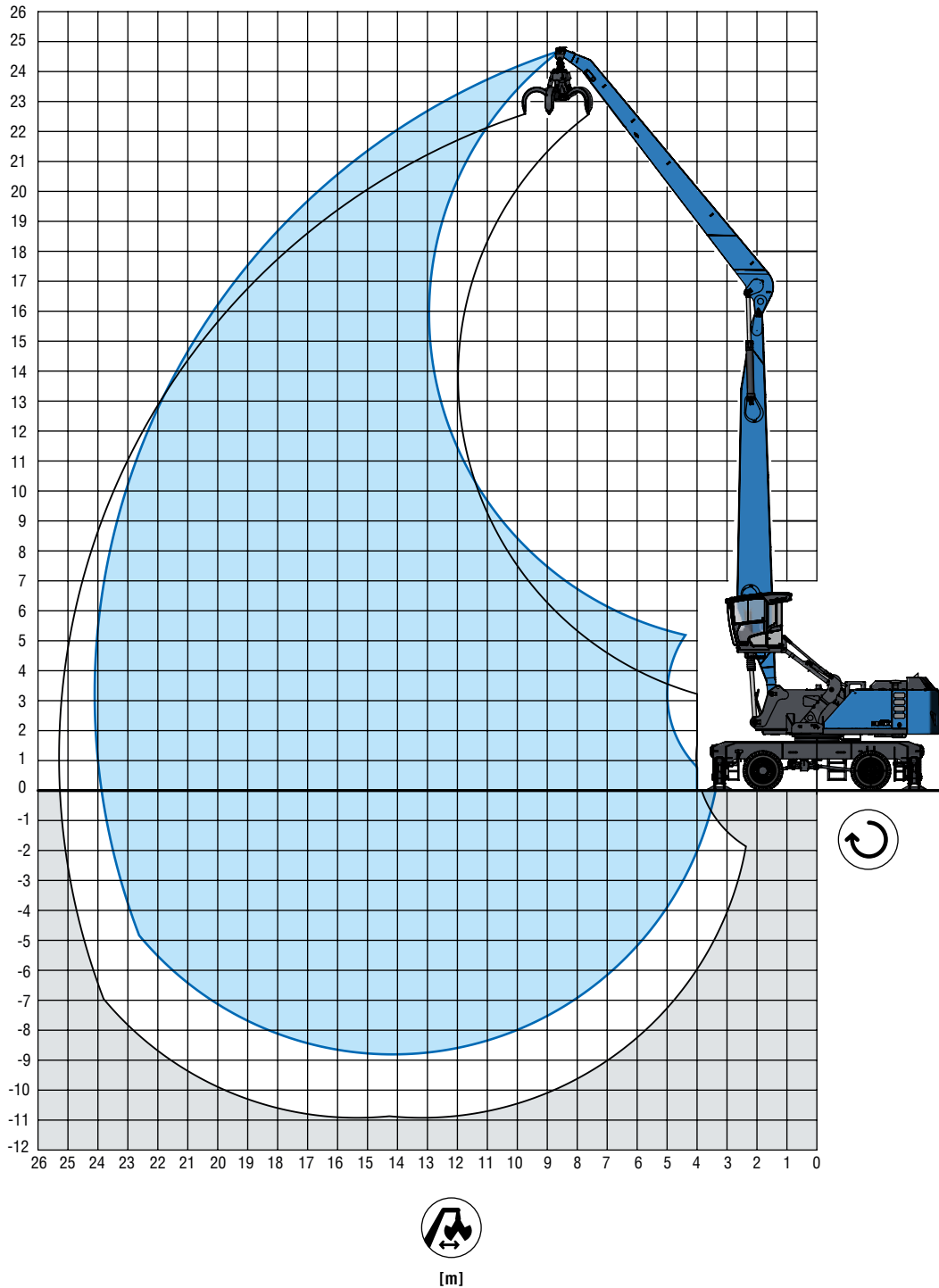

















REACH

24 m with dipper stick

Boom: 12.7 m · Dipper stick: 11 m · Cactus grab: 0.8 m³



LIFTING CAPACITY

		  												
		6 m	7.5 m	9 m	10.5 m	12 m	13.5 m	15 m	16.5 m	18 m	19.5 m	21 m	22.5 m	24 m
22.5 m		7.1° (7.1°)												
21 m		8.3° (8.3°) 7.2° (7.2°) 5.7° (5.7°)												
19.5 m		8.3° (8.3°) 7.2° (7.2°) 5.6° (5.6°)												
18 m		9.0° (9.0°) 8.1° (8.1°) 7.0° (7.0°) 5.3° (5.3°)												
16.5 m		9.0° (9.0°) 8.3° (8.3°) 7.7° (7.7°) 6.6° (6.6°) 4.7° (4.7°)												
15 m		9.0° (9.0°) 8.3° (8.3°) 7.7° (7.7°) 7.1° (7.1°) 6.1° (6.1°)												
13.5 m		9.1° (9.1°) 8.3° (8.3°) 7.7° (7.7°) 7.1° (7.1°) 6.6° (6.6°) 5.1° (5.1°)												
12 m		9.2° (9.2°) 8.4° (8.4°) 7.7° (7.7°) 7.1° (7.1°) 6.6° (6.6°) 6.1° (6.1°)												
10.5 m		10.4° (10.4°) 9.4° (9.4°) 8.5° (8.5°) 7.8° (7.8°) 7.2° (7.2°) 6.6° (6.6°) 6.1° (6.1°) 4.7° (4.7°)												
9 m		12.1° (12.1°) 10.7° (10.7°) 9.6° (9.6°) 8.7° (8.7°) 7.9° (7.9°) 7.2° (7.2°) 6.7° (6.7°) 6.2° (6.2°) 5.6° (5.6°)												
7.5 m		14.7° (14.7°) 12.6° (12.6°) 11.0° (11.0°) 9.8° (9.8°) 8.8° (8.8°) 8.0° (8.0°) 7.3° (7.3°) 6.7° (6.7°) 6.2° (6.2°) 5.6° (5.6°)												
6 m		18.7° (18.7°) 15.6° (15.6°) 13.2° (13.2°) 11.4° (11.4°) 10.1° (10.1°) 9.0° (9.0°) 8.1° (8.1°) 7.4° (7.4°) 6.7° (6.7°) 6.1° (6.1°) 5.6° (5.6°)												
4.5		27.6° (27.6°)	20.6° (20.6°)	16.5° (16.5°)	13.8° (13.8°)	11.8° (11.8°)	10.3° (10.3°)	9.2° (9.2°)	8.2° (8.2°)	7.4° (7.4°)	6.7° (6.7°)	6.1° (6.1°)	5.5° (5.5°)	4.2° (4.2°)
3 m		12.6° (12.6°)	21.8° (21.8°)	17.2° (17.2°)	14.2° (14.2°)	12.1° (12.1°)	10.5° (10.5°)	9.3° (9.3°)	8.3° (8.3°)	7.4° (7.4°)	6.7° (6.7°)	6.1° (6.1°)	5.5° (5.5°)	4.4° (4.4°)
1.5 m		6.5° (6.5°)	14.9° (14.9°)	17.6° (17.6°)	14.5° (14.5°)	12.3° (12.3°)	10.6° (10.6°)	9.3° (9.3°)	8.3° (8.3°)	7.4° (7.4°)	6.7° (6.7°)	6.0° (6.0°)	5.3° (5.3°)	4.3° (4.3°)
0 m		5.6° (5.6°)	10.3° (10.3°)	17.6° (17.6°)	14.5° (14.5°)	12.3° (12.3°)	10.6° (10.6°)	9.3° (9.3°)	8.2° (8.2°)	7.3° (7.3°)	6.5° (6.5°)	5.8° (5.8°)	5.1° (5.1°)	
-1.5 m		5.7° (5.7°)	9.0° (9.0°)	15.2° (15.2°)	14.3° (14.3°)	12.1° (12.1°)	10.5° (10.5°)	9.2° (9.2°)	8.1° (8.1°)	7.2° (7.2°)	6.4° (6.4°)	5.6° (5.6°)	4.8° (4.8°)	
-3 m		6.2° (6.2°)	8.9° (8.9°)	13.5° (13.5°)	13.8° (13.8°)	11.8° (11.8°)	10.2° (10.2°)	8.9° (8.9°)	7.8° (7.8°)	6.9° (6.9°)	6.1° (6.1°)	5.3° (5.3°)	4.4° (4.4°)	
-4.5 m		6.8° (6.8°)	9.1° (9.1°)	12.9° (12.9°)	13.0° (13.0°)	11.2° (11.2°)	9.7° (9.7°)	8.5° (8.5°)	7.4° (7.4°)	6.5° (6.5°)	5.7° (5.7°)	4.8° (4.8°)	3.8° (3.8°)	
-6 m			9.5° (9.5°)	12.9° (12.9°)	11.9° (11.9°)	10.3° (10.3°)	9.0° (9.0°)	7.9° (7.9°)	6.9° (6.9°)	6.0° (6.0°)	5.1° (5.1°)	4.2° (4.2°)		
-7.5 m				10.5° (10.5°)	9.2° (9.2°)	8.1° (8.1°)	7.0° (7.0°)	6.1° (6.1°)	5.2° (5.2°)					
max. reach 24.1 m														
3.3 m		4.0° (4.0°)												

Recommended attachments upon request



Height



Reach



Center of rotation



4-point supported

The lift capacity values are stated in metric tons (t). In accordance with ISO 10567, the lift capacity values represents 75 % of the static tipping loads or 87% of the hydraulic lifting force (marked *). On solid and level ground the values apply to a swing range of 360°. The (...) values apply in the longitudinal direction of the undercarriage. The weights of the attached load hoisting equipment (grab, load hook, etc.) must be deducted from the lift capacity values. The working load of the lifting device must be observed. In accordance with the EN 474-5 for object handling application hose rupture valves on the boom and stick cylinders, an overload warning device and the lift capacity table in the cab are required. The machine has to be supported on a level ground for object handling application.







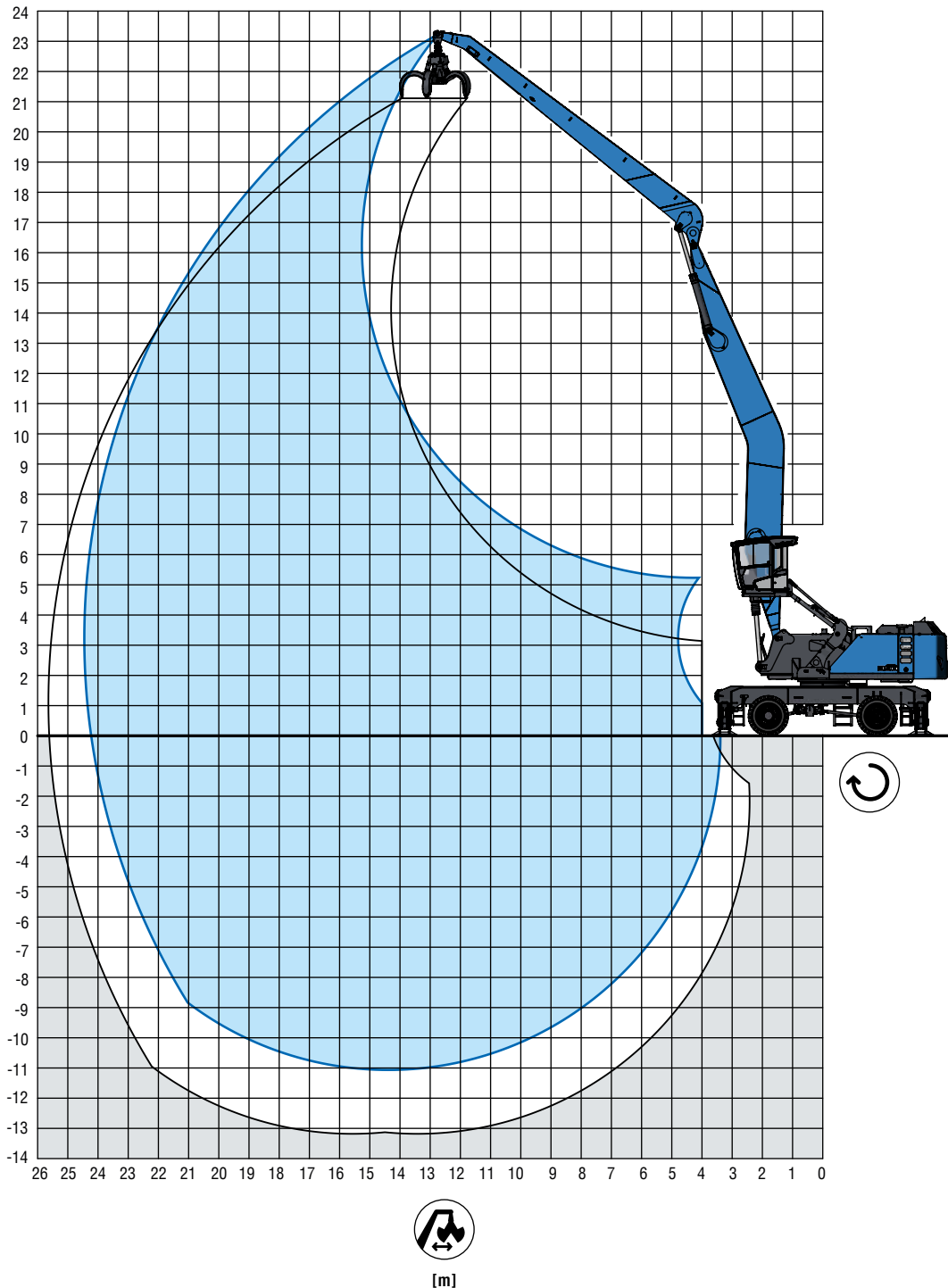















REACH

24.5 m with banana boom

Boom: 13.3 m · Dipper stick: 11 m · Cactus grab: 0.8 m³



LIFTING CAPACITY

															
		6 m	7.5 m	9 m	10.5 m	12 m	13.5 m	15 m	16.5 m	18 m	19.5 m	21 m	22.5 m	24 m	
22.5 m		5.4° (5.4°)													
21 m		5.7° (5.7°)													
19.5 m		7.0° (7.0°) 5.6° (5.6°)													
18 m		6.5° (6.5°) 5.4° (5.4°)													
16.5 m		6.4° (6.4°) 6.0° (6.0°) 4.9° (4.9°)													
15 m		6.4° (6.4°) 6.0° (6.0°) 5.6° (5.6°) 4.1° (4.1°)													
13.5 m		7.0° (7.0°) 6.4° (6.4°) 6.0° (6.0°) 5.6° (5.6°) 5.3° (5.3°)													
12 m		7.1° (7.1°) 6.5° (6.5°) 6.0° (6.0°) 5.6° (5.6°) 5.3° (5.3°) 4.0° (4.0°)													
10.5 m		7.2° (7.2°) 6.6° (6.6°) 6.1° (6.1°) 5.7° (5.7°) 5.3° (5.3°) 4.9° (4.9°)													
9 m		8.1° (8.1°) 7.3° (7.3°) 6.7° (6.7°) 6.2° (6.2°) 5.7° (5.7°) 5.3° (5.3°) 4.9° (4.9°)													
7.5 m		9.4° (9.4°) 8.4° (8.4°) 7.5° (7.5°) 6.8° (6.8°) 6.3° (6.3°) 5.8° (5.8°) 5.3° (5.3°) 4.9° (4.9°) 3.7° (3.7°)													
6 m		13.5° (13.5°) 11.3° (11.3°) 9.8° (9.8°) 8.6° (8.6°) 7.7° (7.7°) 7.0° (7.0°) 6.3° (6.3°) 5.8° (5.8°) 5.4° (5.4°) 4.9° (4.9°) 4.3° (4.3°)													
4.5		24.5° (24.5°)	18.1° (18.1°)	14.3° (14.3°)	11.9° (11.9°)	10.2° (10.2°)	8.9° (8.9°)	7.9° (7.9°)	7.1° (7.1°)	6.4° (6.4°)	5.9° (5.9°)	5.4° (5.4°)	5.0° (5.0°)	4.5° (4.5°)	
3 m		8.6° (8.6°)	19.2° (19.2°)	15.1° (15.1°)	12.4° (12.4°)	10.5° (10.5°)	9.1° (9.1°)	8.1° (8.1°)	7.2° (7.2°)	6.5° (6.5°)	5.9° (5.9°)	5.4° (5.4°)	4.9° (4.9°)	4.5° (4.5°)	
1.5 m		5.7° (5.7°)	11.6° (11.6°)	15.6° (15.6°)	12.7° (12.7°)	10.8° (10.8°)	9.3° (9.3°)	8.2° (8.2°)	7.3° (7.3°)	6.6° (6.6°)	5.9° (5.9°)	5.4° (5.4°)	4.9° (4.9°)	4.4° (4.4°)	
0 m		5.3° (5.3°)	9.0° (9.0°)	15.8° (15.8°)	12.9° (12.9°)	10.9° (10.9°)	9.4° (9.4°)	8.2° (8.2°)	7.3° (7.3°)	6.6° (6.6°)	5.9° (5.9°)	5.4° (5.4°)	4.8° (4.8°)	4.3° (4.3°)	
-1.5 m		5.5° (5.5°)	8.2° (8.2°)	12.9° (12.9°)	12.9° (12.9°)	10.9° (10.9°)	9.4° (9.4°)	8.3° (8.3°)	7.3° (7.3°)	6.5° (6.5°)	5.9° (5.9°)	5.3° (5.3°)	4.7° (4.7°)		
-3 m		6.0° (6.0°)	8.2° (8.2°)	11.8° (11.8°)	12.7° (12.7°)	10.8° (10.8°)	9.3° (9.3°)	8.2° (8.2°)	7.2° (7.2°)	6.4° (6.4°)	5.8° (5.8°)	5.1° (5.1°)	4.5° (4.5°)		
-4.5 m		6.6° (6.6°)	8.4° (8.4°)	11.5° (11.5°)	12.4° (12.4°)	10.5° (10.5°)	9.1° (9.1°)	8.0° (8.0°)	7.1° (7.1°)	6.3° (6.3°)	5.6° (5.6°)	4.9° (4.9°)	4.2° (4.2°)		
-6 m		7.1° (7.1°)	8.8° (8.8°)	11.5° (11.5°)	11.8° (11.8°)	10.1° (10.1°)	8.8° (8.8°)	7.7° (7.7°)	6.8° (6.8°)	6.0° (6.0°)	5.3° (5.3°)	4.6° (4.6°)			
-7.5 m			9.3° (9.3°)	11.8° (11.8°)	10.9° (10.9°)	9.5° (9.5°)	8.3° (8.3°)	7.2° (7.2°)	6.4° (6.4°)	5.6° (5.6°)	4.8° (4.8°)	4.1° (4.1°)			
-9 m				11.3° (11.3°)	9.9° (9.9°)	8.6° (8.6°)	7.5° (7.5°)	6.6° (6.6°)	5.8° (5.8°)	5.0° (5.0°)	4.2° (4.2°)				
-10.5 m					7.5° (7.5°)	6.6° (6.6°)	5.8° (5.8°)	5.0° (5.0°)							
														max. reach 24.4 m	
3.3 m															3.8° (3.8°)

Recommended attachments upon request

-  Height
-  Reach
-  Center of rotation
-  4-point supported

The lift capacity values are stated in metric tons (t). In accordance with ISO 10567, the lift capacity values represents 75 % of the static tipping loads or 87% of the hydraulic lifting force (marked *). On solid and level ground the values apply to a swing range of 360°. The (...) values apply in the longitudinal direction of the undercarriage. The weights of the attached load hoisting equipment (grab, load hock, etc.) must be deducted from the lift capacity values. The working load of the lifting device must be observed. In accordance with the EN 474-5 for object handling application hose rupture valves on the boom and stick cylinders, an overload warning device and the lift capacity table in the cab are required. The machine has to be supported on a level ground for object handling application.

MODULAR SYSTEM

Attachments



Cactus grab



Timber grapple



Magnet plate

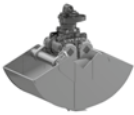

Clamshell grab



Load hook



Work Equipment



Straight

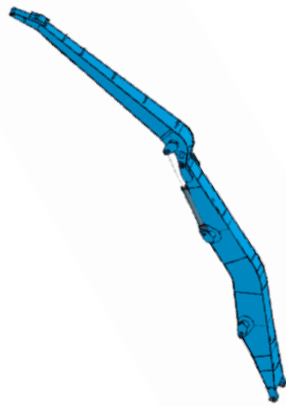

Banana boom

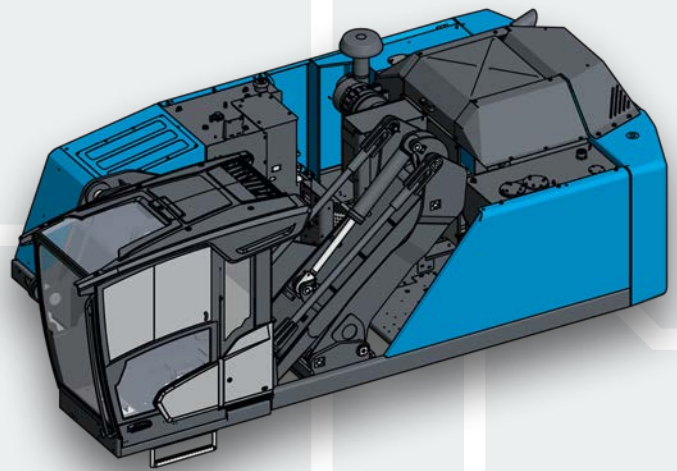

Undercarriage

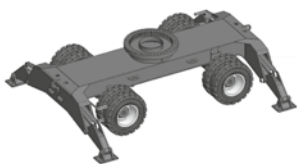

Standard-undercarriage

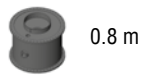

0.8 m

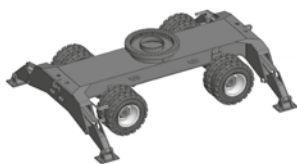

Standard-undercarriage



1.4 m

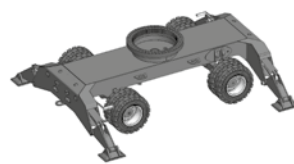

XL-undercarriage

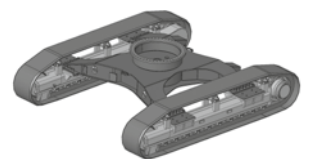

Crawler

Cab Systems

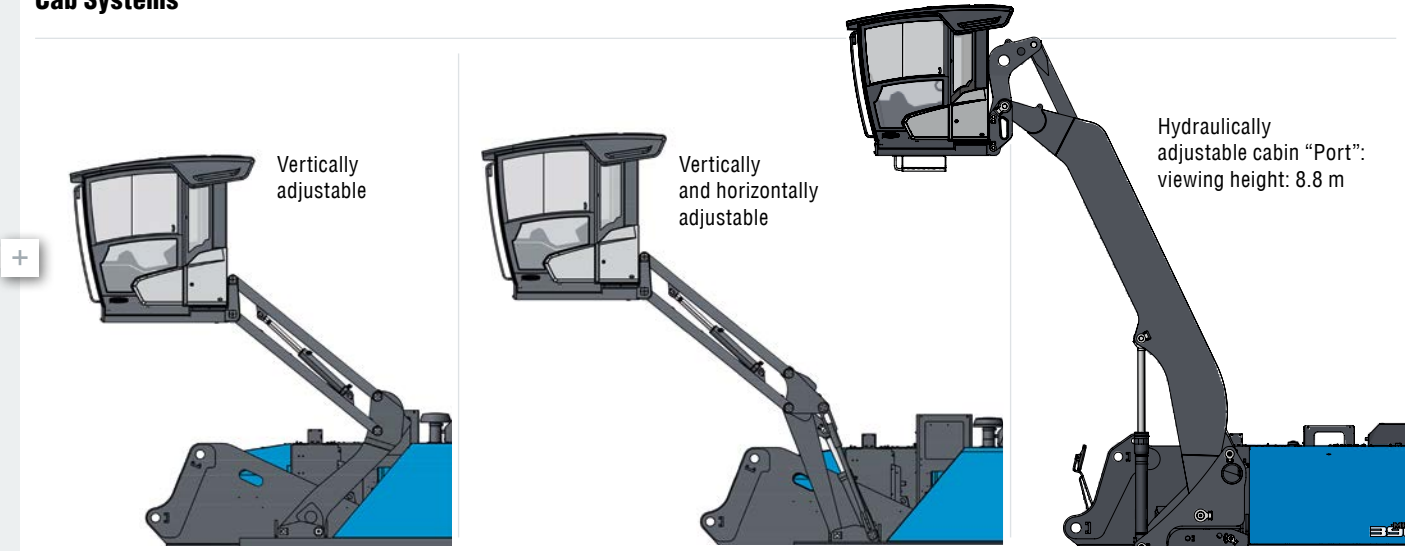

Engines

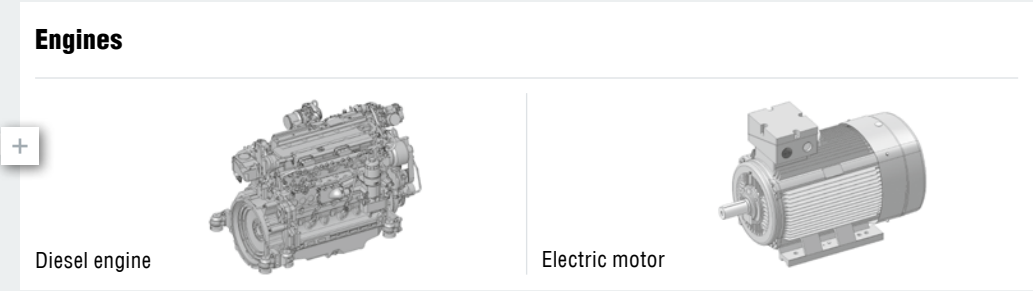

Options

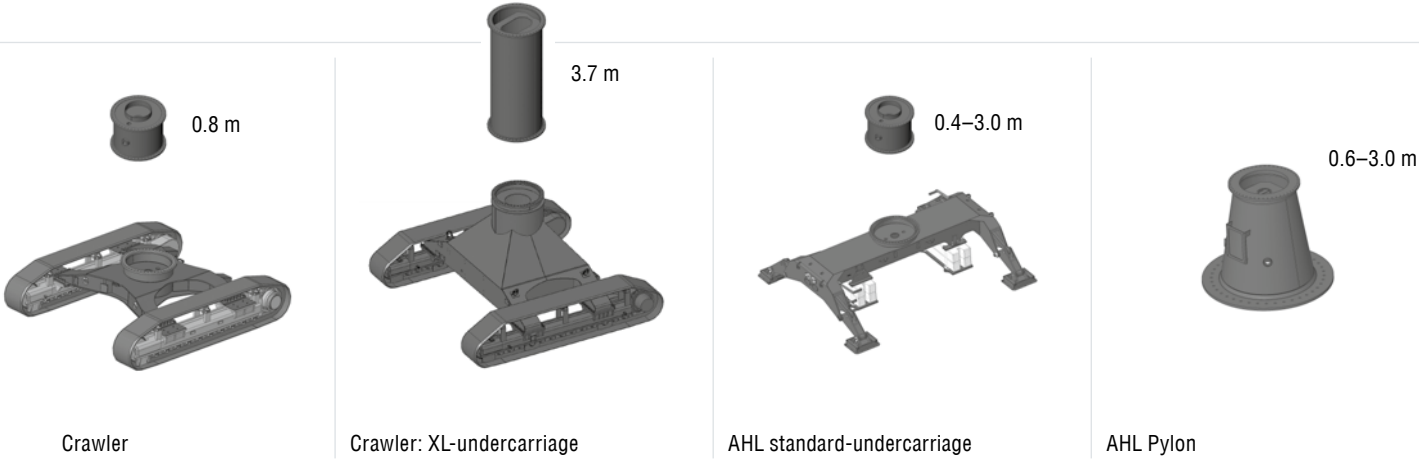
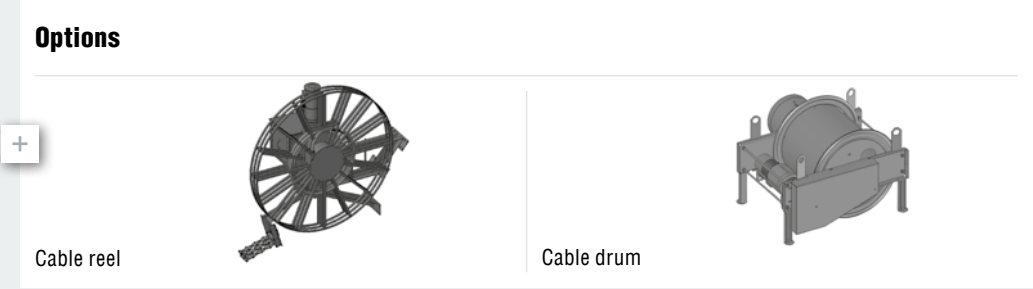



www.terex-fuchs.com

July 2021. Product specifications and prices are subject to change without notice or obligation. The photographs and/or drawings in this document are for illustrative purposes only. Refer to the appropriate Operator's Manual for instructions on the proper use of this equipment. Failure to follow the appropriate Operator's Manual when using our equipment or to otherwise act irresponsibly may result in serious injury or death. The only warranty applicable to our equipment is the standard written warranty applicable to the particular product and sale and Terex makes no other warranty, express or implied. © Terex Corporation 2021 - Terex, the Terex Crown design, Fuchs and Works For You are trademarks of Terex Corporation or its subsidiaries.

Terex® Deutschland GmbH | Industriestraße 3 | 76669 Bad Schönborn | Germany | Fon: +49 (0) 7253 84-0 | Fax: +49 (0) 7253 84-102 | info@terex-fuchs.com

