

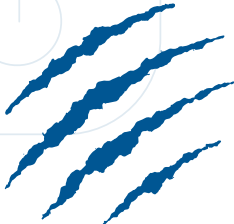

PACKAGING AND CONTENT RECOVERY SOLUTION



**TIGER DEPACK®**  
PRODUCT LINE



TIGER DEPACK

- TIGER DEPACK
- PROCESSES
- DEPACKAGING
- RECOVERY
- PRODUCTION
- HOW IT WORKS
- PAPER PULP SOLUTION
- OVERSIZE CLEANING
- SAFETY TECHNOLOGY
- RELIABILITY & EFFICIENCY
- ACCESSORIES & INNOVATIONS
- WORLDWIDE SERVICE
- TIGER DEPACK SYSTEM
- TIGER DEPACK PLANTS
  
- PRODUCT LINE
- TIGER DEPACK HS 20 UNIT
- TIGER DEPACK HS 10 UNIT
- TIGER DEPACK HS 5 UNIT
  
- REFERENCES

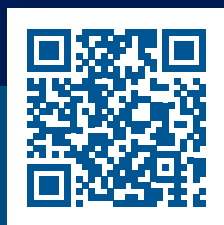

Find out more  
[www.tigerdepack.com](http://www.tigerdepack.com)



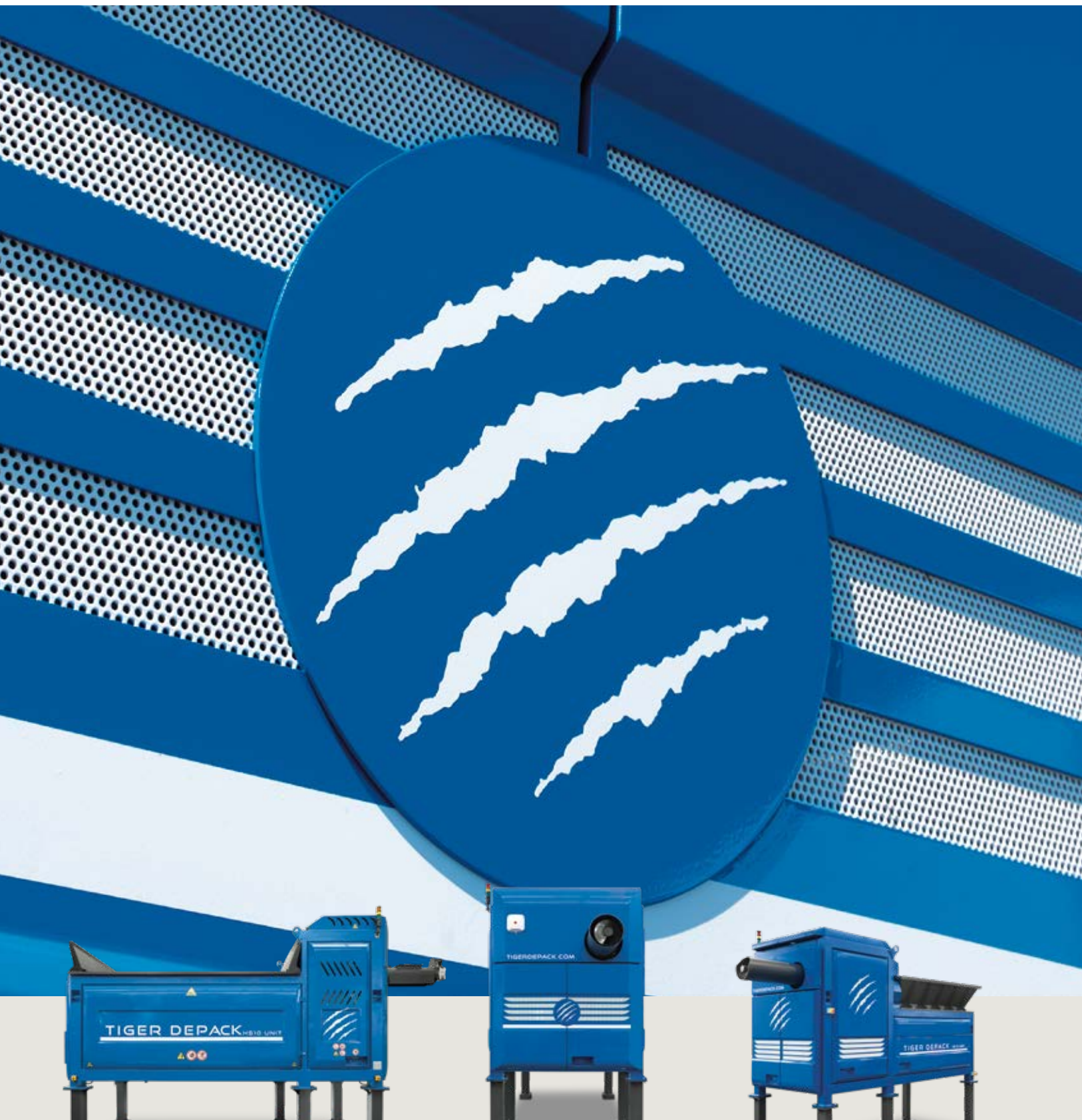

PACKAGING AND CONTENT RECOVERY SOLUTION

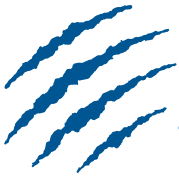

# THE TIGER DEPACK SYSTEM

Tiger Depack is the brand that encompasses the trademarked technologies developed for the depackaging of packaged products and the separation of materials for the Recovery, Production and Depackaging sectors.

Tiger Depack is by now the technological benchmark in many countries as trusted supplier and technological partner of the major benchmark companies in the production of daily consumer goods, waste treatment, animal nutrition, anaerobic digestion and composting in more than 150 plants throughout Europe, Australia, Canada and the US.

Manufacturing companies that want to directly recover their own production waste from their lines and waste treatment plants, represent our main customer base with whom we have honed this technology over the last 15 years.

Our brand is part of Cesaro Mac Import SRL, the Italian leader in the waste treatment plant sector.



## MASS BALANCE

**INPUT  
100%  
IN WEIGHT**

BEFORE TIGER  
DEPACK TECHNOLOGY

WITH  
TIGER DEPACK

- SQUEEZING
- SHREDDING + SCREENING
- HORIZONTAL SEPARATION

**TIGER DEPACK SYSTEM**

# THIS IS WHY WE DESIGNED TIGER DEPACK

★ PATENTED ★

Designed to carry out the pretreatment of packaged products, extracting an excellent quality of output material in the smallest space, with the maximum connectivity and lowest possible energy consumption.



RECOVERED  
70% - 30% IN WEIGHT

REJECT  
30% - 70% IN WEIGHT

RECOVERED  
97% - 90% IN WEIGHT

REJECT  
3% - 10% IN WEIGHT



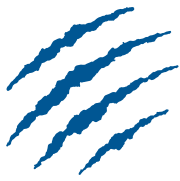

## PROCESSES

Tiger's de-packagers are used in a multitude of processes grouped into three macro categories:

### DEPACKAGING RECOVERY PRODUCTION

The main processes performed by Tiger de-packagers include the de-packaging of Source Separated Organic (SSO) or expired products, the recovery of rejects generated by waste treatment plants and consumers goods production facilities.

#### DE-PACKAGING THE MORE KNOWN SECTOR IN WHICH TIGER DEPACK OPERATES

Recover packaging and its contents obtaining the highest quality required for the both of them valorization. Defined and reusable packing such as for out-of-date food, cartons, tetrapack, ferrous and non-ferrous metal tins. Clean content as food, beverages, organic matter for AD/composting, detergents and cosmetics.

#### DEPACKAGING



PRE-TREATMENT OF FOOD WASTE

TIGER HAS BEEN THE BEST TECHNOLOGICAL SOLUTION FOR THE TREATMENT OF THE MOST COMPLEX MATERIAL TO RECOVER FOR OVER 10 YEARS.



### THE SECOND PROCESS IS THE RECOVERY OF REJECTS

Tiger de-packagers recover till to 97% of interest matter processing Paper Pulp and Pre-Treatment Plastics, experience demonstrates.

### THE THIRD PROCESS IS PRODUCTION

By introducing the Tiger Depack into the consumers goods production facilities process line it is possible now to reduce reject production directly at the source.



RECOVERY OF REJECTS

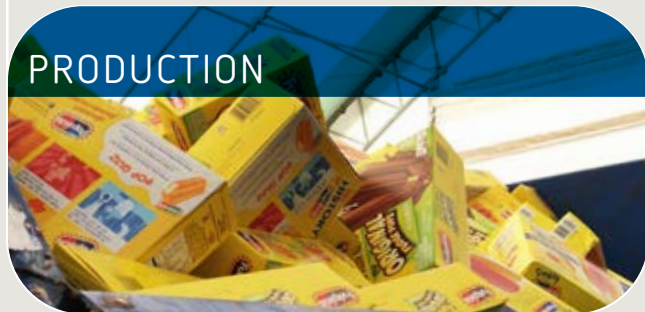

DE-PACKAGING OF PRODUCTS



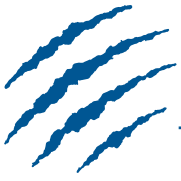





# DEPACKAGING

## WASTE TREATMENT PLANTS

### SEPARATE ORGANIC FROM PACKAGING

#### MATRIX

**ORGANIC WASTE:** generated by a multitude of sources as roadside collection, markets, grocery stores, and large-scale retailers as well as from stations, ports and airports.

**FAULTY/EXPIRED PRODUCTS:** Foodstuffs, cosmetics and detergents.

#### PERFORMANCE:

When introduced into waste treatment plants, the Tiger Depack can be used to recover the organic/content fraction as well as the dry material/packaging, obtaining 2 streams suitable for subsequent recycling and repurposing.





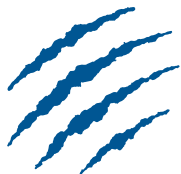

TIGER DEPACK







# RECOVERY

PAPER MILL AND WASTE TREATMENT PLANTS

## RECOVER MATRICES OF VALUE FROM REJECTS

### MATRIX

**PLASTIC REJECTS:** Plastic waste from the pre-treatment of Source Separated Organic and Expired Food.

**PAPER PULP:** Waste from the paper-making processes.

### PERFORMANCE:

Tiger's de-packagers are able to recover even rejects generated, for instance, by Paper Production or Waste Treatment Processes.

Products composition of this category substantially differs from Packaged ones or Food Waste.

Tiger de-packagers, in this case, are able to recover a intermediate processing reject.





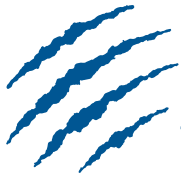





# PRODUCTION

PRODUCTION SITES

SEPARATES CONTENT FROM ITS PACKAGING

## MATRIX

All types of production waste in paper/  
cardboard, tetrapack, nonferrous,  
ferrous metals and plastics.

## PERFORMANCE:

In an integrated production line, the Tiger  
Depack separates content from its packaging  
with an overall recovery approaching 100%.



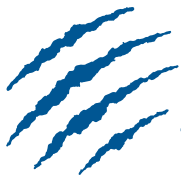

# HOW IT WORKS

TIGER DEPACK'S TECHNOLOGY IS PATENTED!

Vertical separation is at the heart of the Tiger Depack system's technology. This results in the processing of heterogeneous materials, highest recovery performance, operational reliability even in h24 working shifts.

INPUT  
100%  
IN WEIGHT

1

TIGER  
DEPACK  
SYSTEM

2

3

OUTPUT

- Close to 100% recovery of the organic material.
- Economical valorization of separated packaging.
- Vertical separation system ensures the material recovery obtaining the highest quality possible
- Maximizing the throughput
- Minimizing wear and tear of the machine.





★ PATENTED ★

The extreme efficiency of the tiger system allows it to operate with or without the addition of water or process liquids. Thus, perfect outputs are obtained for any type of subsequent process from wet or dry anaerobic digestion to direct composting.



ORGANIC OUTPUT  
+ WEIGHT  
+ QUALITY



PACKAGING OUTPUT  
- WEIGHT  
+ QUALITY





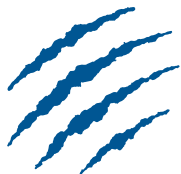

## PAPER MILL PULP INPUT







# TIGER DEPACK PPS PAPER PULP SOLUTION

The Technological Upgrade of the Tiger UNIT is the specific version for the processing requirements of Paper Pulp Waste. The ease with which it can be introduced within an existing production cycle, both in indoor facilities as well as outdoors, owing to its reduced overall dimensions and its easy connection make the Tiger PPS the perfect solution to the needs of any Paper Mill. A single, unique machine which, owing to its particular selection system, is able in a single process to reduce by up to **70%** the quantity of material currently sent for disposal.

## DATA SHEET

Installed Power	106,5 Kw
Average hourly electricity consumption	70 kW/h
Weight	12 t
Occupied surface area of	21 m <sup>2</sup>

The recovered material consists of water, which is then re-used in the production cycle, and up to **30%** of Paper fiber or pulp. Up until now, this material was lost, together with the waste pulp, which therefore meant further economic loss for the Paper Mill.

The extra-low running costs and the 24-hour processing capacity of the Tiger PPS make it the most efficient and effective tool to introduce into the paper production cycle.

Over 90% of paper fiber is recovered from the treated waste

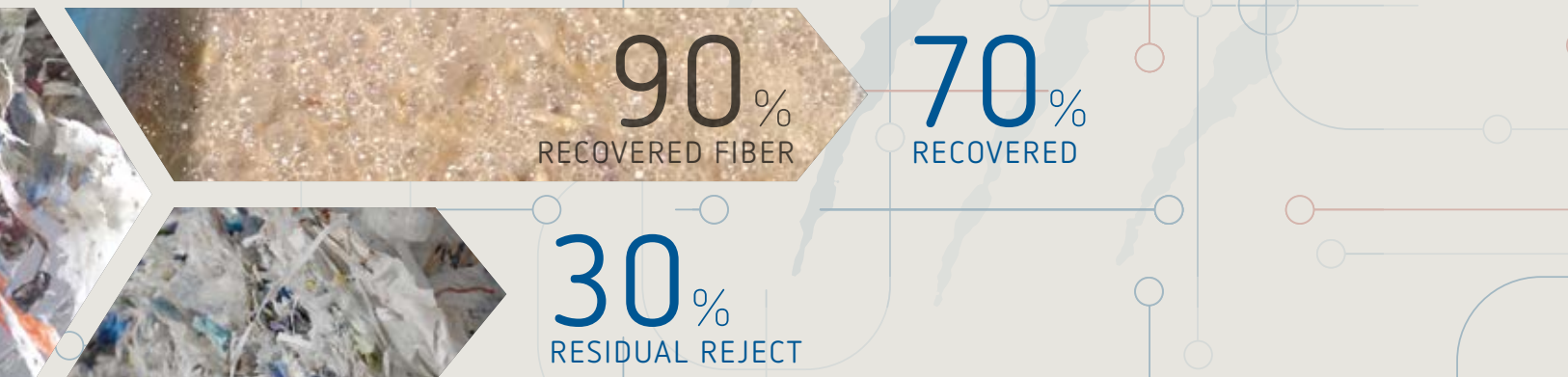



## PLASTIC WASTE INPUT

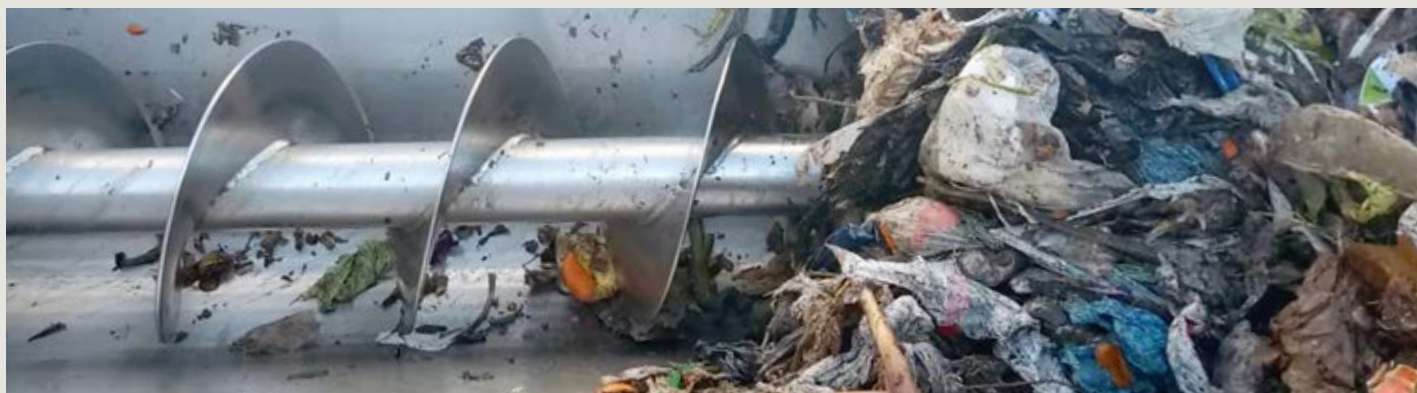





## TIGER DEPACK OSC

### OVERSIZE CLEANING

Tiger Depack OSC is the specific version for processing Plastic Wastes generated by Waste Treatment Plants.

Waste treatment cycles require process passages and it is unavoidable to produce rejects, even if in small percentages, for each of them.

Plastic represents the one of the main present component of these rejects and, often,

its quality do not completely fulfill mass balance expectation for a high performance facility.

**Tiger Depack it makes possible to obtain two fundamental advantages:**

**+ Till 97% organic fraction recovery** still contained in the Plastic Waste

**+ Till 80% weight reduction of Plastic Waste** to be disposed.

### TIGER OSC MAY BE APPLIED

- In the anaerobic digestion plants for the preparation of the substrate to be sent to the digester.
- In the composting plants for the preparation of wet to send to mixing with the green.
- In all installations Waste treatment for cleaning reusable fractions.

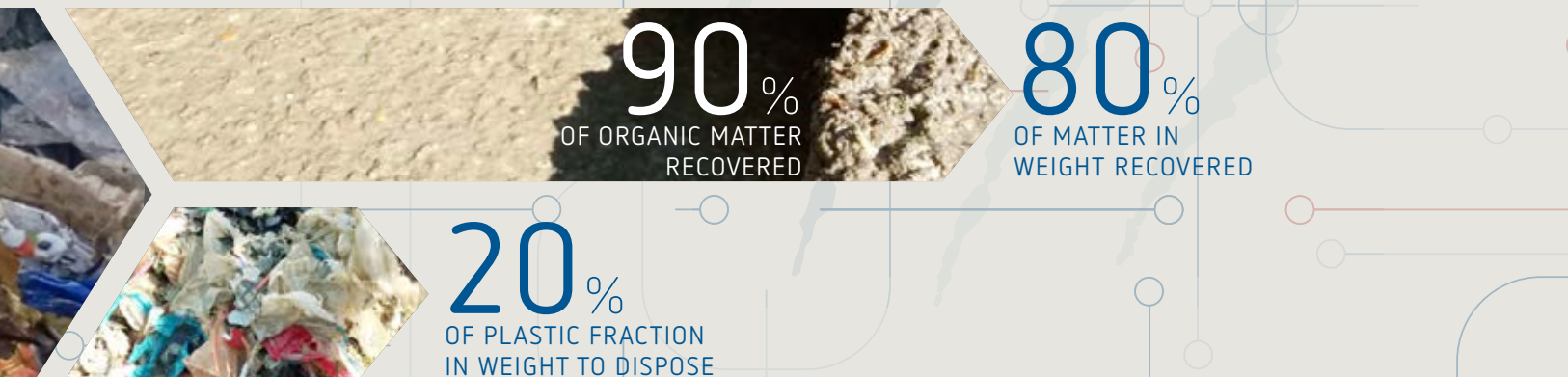

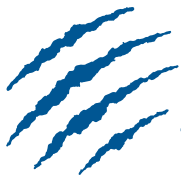

# SAFETY TECHNOLOGY

- **Lockable and alarmed** external hatches for accessing compartments with moving parts
- **Open hatch alarms** and automatic shut-down of moving parts
- **Manual alarm** buttons
- **Hatches with self-locking** screws to internal compartments
- **Emergency lighting** signalling In Use
- **Integrated control board** within the body of the machine in a protected and isolated position
- Tiger Depack **Emergency Circuit** which can be integrated with the target system's emergency circuit
- **Lifting hooks** fitted for lifting/handling machinery
- **Easy access** to all parts of the machine for maintenance at any time
- **Planned maintenance** by specialist staff, worldwide



TIMELY DIAGNOSIS OF THE ALARMS



TELEMETRY FOR INCREASED PERFORMANCE



INTUITIVE PARAMETER ADJUSTMENT



# RELIABILITY & EFFICIENCY

- Optimized **automatic processing cycle** with set parameters
- Machines suitable for **indoor or outdoor** processing
- Robust components, structure and frame **designed for heavy workloads**
- Production **capacity over a 24/7** processing cycle
- **Low maintenance**
- **Remote service**
- **Oversized electrical** motor in relation to the power required
- Automated **end-of-day cleaning cycle**
- **Internet connected**



CHASSIS INTEGRATED ELECTRICAL PANEL



DOOR OPENING ALARM



PASSIVE AND ACTIVE SAFETY SYSTEMS

Tiger Depack do not tolerate any compromise when it comes to the safety of their machines. Passive and active systems control functionality, even from remote locations, which conform with the strictest laws on safety.

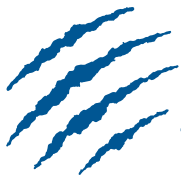

The Tiger Depack's optional extras and accessories are available for all versions, offering increased adaptability to whatever process they are installed in.



SILENT BLOCK  
MINIMIZE POSSIBLE  
VIBRATIONS



PROCESS LIQUID  
REGULATION



SYSTEMS FOR WET FRACTION  
DISCHARGE AVAILABLE



HOPPER IN STAINLESS  
STEEL



### DISCHARGE SYSTEMS

- Packaging Extractor auger embedded
- Content Discharge System for both Wet and Dry processes available as accessory

### INTEGRATED HARDWARE/SOFTWARE AND MEASURING ACCESSORIES

- Profibus Module
- Loading cells
- User friendly
- PID regulation
- Allarm identification
- Telemetry processing

# ACCESSORIES & INNOVATIONS

### DOOR PAINTING AND LUBRICATION

- Sliding doors
- Automatic lubrication device with timer
- Bodywork color options

Accessories can also be installed  
after Tiger de-packager purchase



INTEGRATED PACKAGING  
EXTRACTOR



SLIDING DOORS



INTERNET CONNECTED

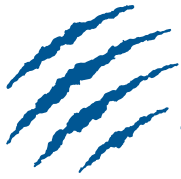

## WORLDWIDE SERVICE

Tiger Depack trademarked is the brand that encompasses the technologies dedicated to recover of the most specific wastes to be integrated into recycling field.



The spearhead of the Tiger Depack System is the **Worldwide Assistance Service** it offers for its machines. The ability to provide our customers with **warranties and planned assistance**, as well as the possibility of remote monitoring, make the Tiger Depack an efficient and effective system.

A system that can guarantee the availability of **spare parts** and qualified staff capable of providing a rapid response to our customer's needs.





# MORE THAN 150 TIGER DEPACK IN THE WORLD

- USA ★
- ENGLAND ★
- SPAIN
- FRANCE ★
- ITALY
- FINLAND
- AUSTRALIA ★
- CANADA ★
- POLAND ★
- HOLLAND
- NORWAY ★
- HUNGARY
- UKRAINE ★
- LITHUANIA
- RUSSIA ★
- IRELAND ★
- SOUTH KOREA ★

## LEGEND

- ★ DEALER
- MACHINE



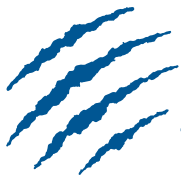

TIGER DEPACK

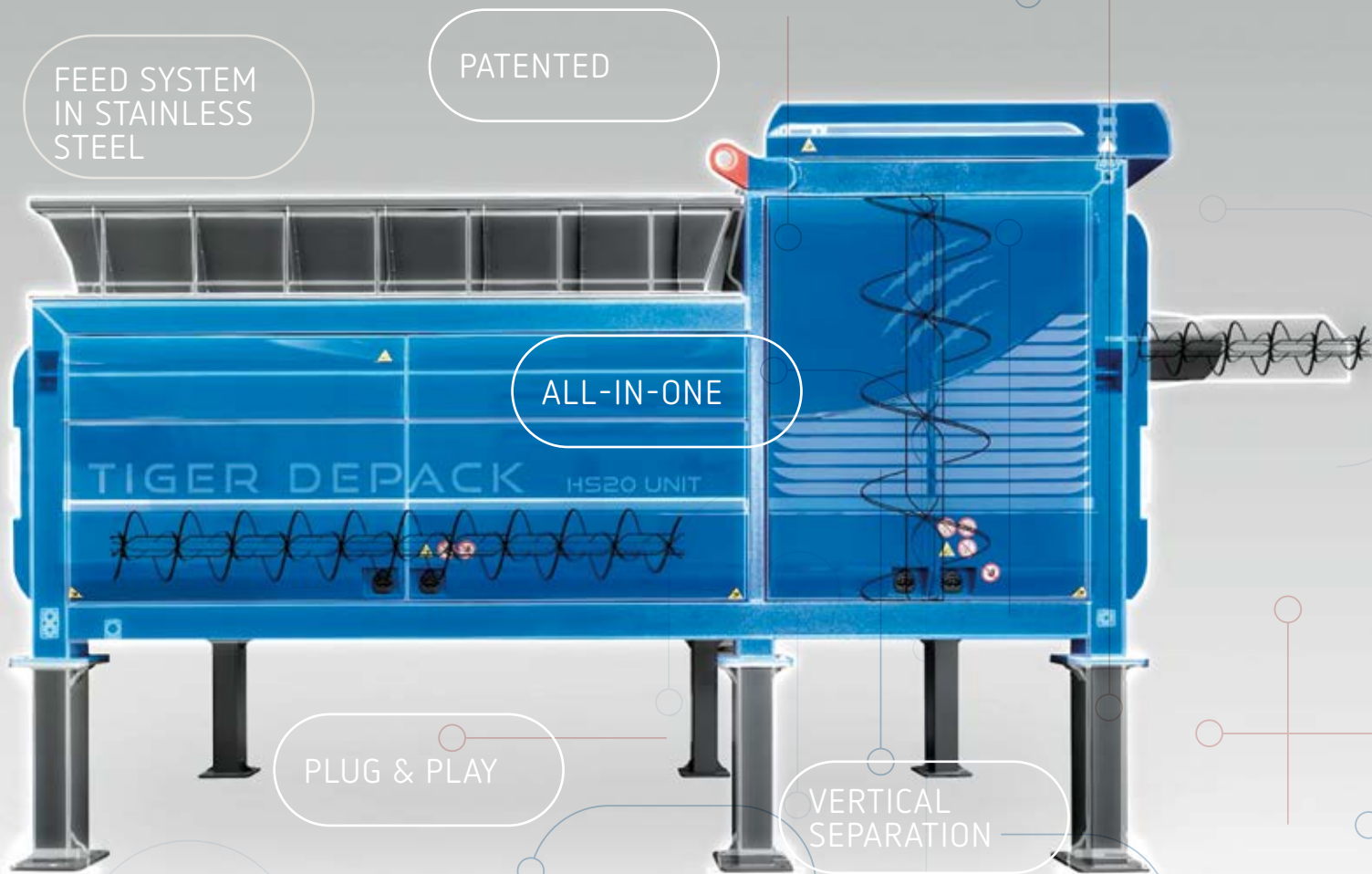

## TIGER HS20

AVAILABLE IN  
THE UNIT SETUPS

TIGER HS20  
UNIT  
STANDARD  
SETUP

TIGER HS20  
PPS  
SETUP FOR  
PAPER MILL  
PULP

TIGER HS20  
OSC  
SETUP FOR  
PLASTIC  
CLEANING

## TIGER HS10



# TIGER DEPACK SYSTEM

Vertical separation is at the heart of the Tiger Depack systems technology. This results in the processing of heterogeneous material intended for disposal performing maximum throughput and the highest recovery.



Assembling feed hopper next to the separation group has requested a technical solution aimed to simplification.

Both compartment, feeding and treating, are managed by a single operating software that governs the augers' speed, based on the settings provided and by the characteristics of the material being loaded.

**Compact, All-in-One and Plug & Play, that's Tiger.**

Thanks to its extremely compact design, the Tiger Depack is an All-in-One solution insofar as all the components it requires to operate are enclosed within its chassis.

The usage of components and materials such as Hardox and Stainless Steel has allowed spare parts to be replaced less than half as much as competing products.

Thanks to these features, Tiger Depack is the most compact and reliable machine on the market with the lowest operating costs (per ton processed).

## PRODUCT LINE

AVAILABLE IN THE UNIT SETUPS

**TIGER HS10  
UNIT  
STANDARD  
SETUP**

### TIGER HS5

AVAILABLE IN THE UNIT SETUPS

**TIGER HS5  
UNIT  
STANDARD  
SETUP**

**TIGER HS5  
PPS  
SETUP FOR  
PAPER MILL  
PULP**

**TIGER HS5  
OSC  
SETUP FOR  
PLASTIC  
CLEANING**

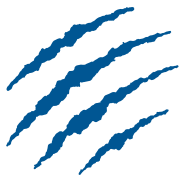

- Temporary storage for shredded vegetable waste
- Receiving doors/hall - Pre-Processing System
- Processing Area / Anaerobic Digesters
- Processing Area / Composters
- Post-Processing System and Product/Byproduct Storage Areas
- Air Collection and Odour Control & Treatment System

44.000 Tons of waste per year  
 33.000 tons of organic waste  
 11.000 tons of green waste  
**capacity of the plant is about 100 t/day**

## TIGER IS SUITABLE FOR

In the anaerobic digestion plants for the preparation of the substrate to be sent to the digester.

In the receiving stations and transfer of organic waste to carry out a preliminary treatment of the matrix.

In the recovery and processing of expired packaged food.

In the food industry for the recovery of production waste.

In the composting plants for the preparation of wet to send to mixing with the green.

In all installations Waste treatment for cleaning reusable fractions.

In the bottling industries for the reduction of process wastes to be sent to landfill.

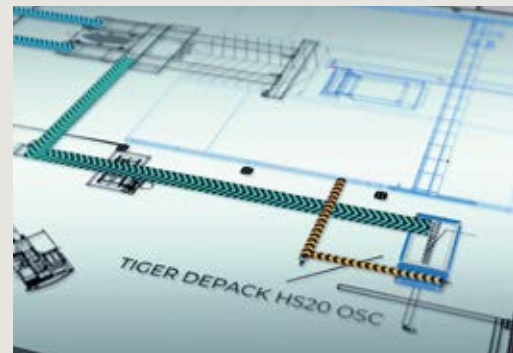
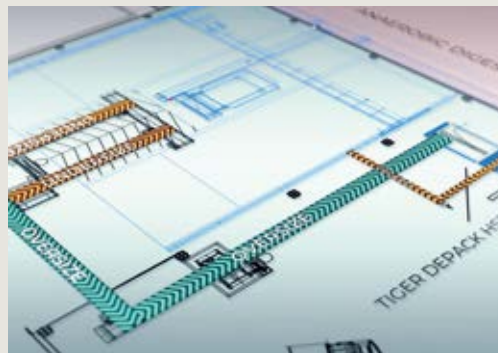



# TIGER DEPACK PLANTS

The organic fraction of waste is usually the predominant part of waste coming from municipal collection or from waste generated in production processes. And also the most complex to manage.

The two plants shown by way of example allow you to notice a further typology of insertion of Tiger's de-packagers.

These Bio-Methane and Electricity production sites produced by Anaerobic Digestion have inserted Tiger HS20 OSC after start-up.

The objective achieved by HS20 OSC in these two cases allows to recover over 90% of the organic fraction still present in the plastic waste from Pre-Treatment.

The challenge successfully achieved by Tiger Depack is even more significant given the need for dry process.

## BENEFITS

Organic Fraction recovered from Plastic Waste  
+ over 90% organic matter sent to energetic valorization

Reduction of the Produced Rejects  
+ cat of disposal cost till 80%



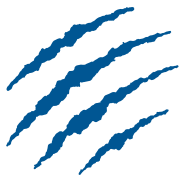

# TIGER DEPACK HS 20 UNIT

The Tiger HS 20 UNIT was created to handle increased processing capacities. Applicable in the fields of Depackaging and Recovery where large production quantities are required. This is the largest and most powerful machine in the Tiger Depack range.

## DATA SHEET

### TIGER HS 20 UNIT STANDARD HOPPER 15-25 t/h

HOPPER	Standard hopper AISI 304	5,4 m <sup>3</sup>
LEGS	Standard legs	1,200 mm
SEPARATION	Basket in STEEL S700, Shaft, Paddles, Bearings	
PLASTIC EXTRACTION	Dry fraction extractor screw	
ENGINES	ABB engine for the shaft	90 kW
	Engine with gearmotor for the feeding hopper	11 kW
	Engine with gearmotor for the extraction screw	5,5 kW
LIQUIDS	Double water input line: process water line and washing line	
	Solenoid valve for the regulation of the incoming water flow	
	Liter counter	
ELECTRICAL AND SOFTWARE	Control panel with touchscreen	
	Software	
	Soft starter	90 kW
	Frequency Converter	11 kW
	Electric cabinet	
	Rotation sensor for rotor	

Specifications subject to technical changes. Specifications are approximate, illustrations and may include options that are not part of the standard equipment.



OPERATING DIMENSION mm		
A	hopper loading height	3,200
B	hopper loading width	3,500
C	plastic discharge height	3,000







**OVERALL MACHINE DIMENSIONS mm**

<b>D</b>	max length	7,550 = H+I
<b>E</b>	max width	2,500
<b>F</b>	max frame height	2,960
<b>G</b>	max height	4,160 = F+L
<b>H</b>	external length of plastic extractor	1,100
<b>I</b>	frame length	6,450
<b>L</b>	height of standard legs	1,200



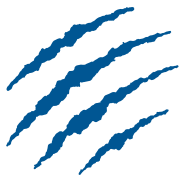

# TIGER DEPACK HS 10 UNIT

The Tiger HS 10 is Tiger Depack's spearhead product. Created as the Tiger HS it is the base machine which is suitable for meeting a variety of requirements as a result of its size and productivity.

## DATA SHEET

### TIGER HS 10 UNIT STANDARD HOPPER 10 t/h

HOPPER	Standard hopper AISI 304	5,4 m <sup>3</sup>
LEGS	Standard legs	1,200 mm
SEPARATION	Basket in STEEL S700, Shaft, Paddles, Bearings	
PLASTIC EXTRACTION	Dry fraction extractor screw	
ENGINES	ABB engine for the shaft	55 kW
	Engine with gearmotor for the feeding hopper	5,5 kW
	Engine with gearmotor for the extraction screw	3 kW
LIQUIDS	Double water input line: process water line and washing line	
	Solenoid valve for the regulation of the incoming water flow	
	Liter counter	
ELECTRICAL AND SOFTWARE	Control panel with touchscreen	
	Software	
	Soft starter	55 kW
	Frequency Converter	5,5 kW
	Electric cabinet	
	Rotation sensor for rotor	

Specifications subject to technical changes. Specifications are approximate, illustrations and may include options that are not part of the standard equipment.

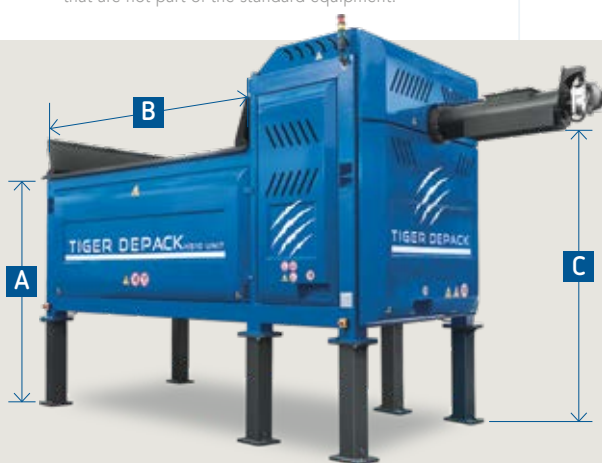

OPERATING DIMENSION mm		
A	hopper loading height	3,300
B	hopper loading width	3,500
C	plastic discharge height	3,150

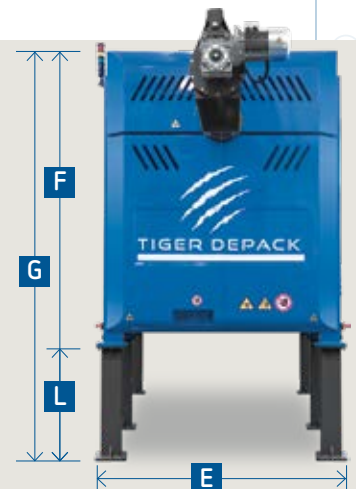





**OVERALL MACHINE DIMENSIONS mm**

<b>D</b>	max length	7,400 = H+I
<b>E</b>	max width	2,500
<b>F</b>	max frame height	2,960
<b>G</b>	max height	4,160 = F+L
<b>H</b>	external length of plastic extractor	1,600
<b>I</b>	frame length	5,800
<b>L</b>	height of standard legs	1,200



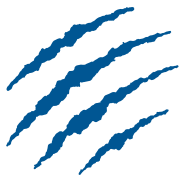

# TIGER DEPACK HS 5 UNIT

The Tiger HS 5 UNIT is the smallest version of the Tiger Depack range. Born from the specific need to be installed in more restricted spaces, the Tiger HS 5 UNIT features the same separation and depackaging qualities as the larger version.

## DATA SHEET

### TIGER HS 5 UNIT STANDARD HOPPER 3-7 t/h

HOPPER	Standard hopper AISI 304	1,5 m <sup>3</sup>
LEGS	Standard legs	700 mm
SEPARATION	Basket in STEEL S700, Shaft, Paddles, Bearings	
PLASTIC EXTRACTION	Dry fraction extractor screw	
ENGINES	ABB engine for the shaft	30 kW
	Engine with gearmotor for the feeding hopper	5,5 kW
	engine with gearmotor for the extraction screw	4 kW
LIQUIDS	Double water input line: process water line and washing line	
	Solenoid valve for the regulation of the incoming water flow	
	Liter counter	
ELECTRICAL AND SOFTWARE	Control panel with touchscreen	
	Software	
	Soft starter	30 kW
	Frequency Converter	5,5 kW
	Electric cabinet	
	Rotation sensor for rotor	

Specifications subject to technical changes. Specifications are approximate, illustrations and may include options that are not part of the standard equipment.

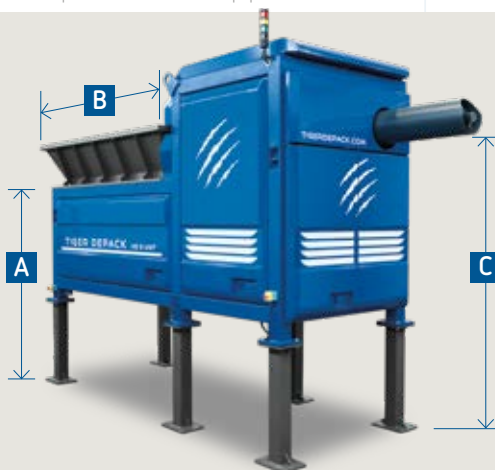

OPERATING DIMENSION mm		
A	hopper loading height	3,300
B	hopper loading width	2,250
C	plastic discharge height	3,000

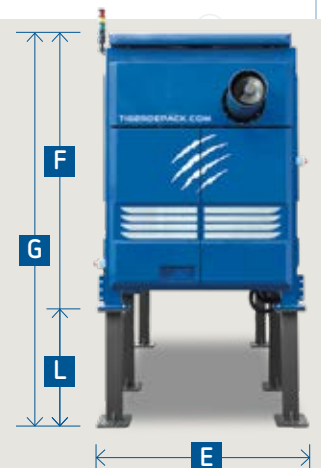





**OVERALL MACHINE DIMENSIONS mm**

<b>D</b>	max length	5,600 = H+I
<b>E</b>	max width	2,000
<b>F</b>	max frame height	2,700
<b>G</b>	max height	3,900 = F+L
<b>H</b>	external length of plastic extractor	900
<b>I</b>	frame length	4,650
<b>L</b>	height of standard legs	1,200

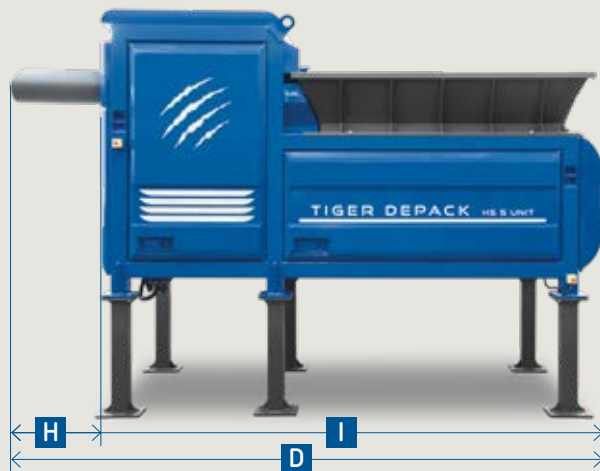

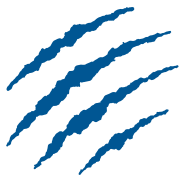

TIGER DEPACK



TIGER DEPACK HS 20 PPS (ITALY)  
PAPER PULP

TIGER DEPACK HS 5 (ITALY) /  
SOURCE SEPARATED ORGANIC



## TIGER DEPACK REFERENCES



TIGER DEPACK HS 10 (POLAND) /  
WASTE TREATMENT REJECTS



TIGER DEPACK HS 10 (NORWAY) /  
FOOD WASTE





TIGER DEPACK HS 10 (U.S.A) /  
WASTE FROM CAFETERIAS



TIGER DEPACK HS 640 (ENGLAND) /  
ORGANIC FRACTION OF URBAN SOLID WASTE  
FROM DIFFERENTIATED WASTE DISPOSAL



TIGER DEPACK HS 640 (FINLAND) /  
ORGANIC FRACTION OF URBAN SOLID WASTE  
FROM DIFFERENTIATED WASTE DISPOSAL



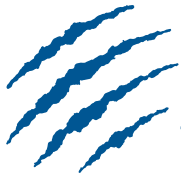

TIGER DEPACK HS 5 (ITALY) /  
SOURCE SEPARATED ORGANIC

TIGER DEPACK HS 640 (ITALY) /  
EXPIRED FOOD



TIGER DEPACK HS 10 UNIT (FRANCE) /  
SOURCE SEPARATED ORGANIC





# TIGER DEPACK REFERENCES

TIGER DEPACK HS 20 OSC (ITALY) /  
WASTE TREATMENT REJECTS



TIGER DEPACK HS 5 (ITALY) /  
SOURCE SEPARATED ORGANIC



TIGER DEPACK HS 20 PPS (ITALY) /  
PAPER PULP

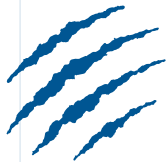

**TIGER DEPACK®**  
PACKAGING AND CONTENT RECOVERY SOLUTION

VIA DELLE INDUSTRIE 28 E 29  
I - 30020 ERACLEA (VE) ITALY  
+39 0421 231101  
[WWW.TIGERDEPACK.COM](http://WWW.TIGERDEPACK.COM)

